

Please note that the data given here has been taken from the online catalog. For comprehensive information and data, please refer to the user documentation at <http://www.download.phoenixcontact.com>. The General Terms and Conditions of Use apply to Internet downloads.

▶ Extract from the online catalog



POWER COMBICON headers, 10.16 mm pitch, color: Green, no. of positions: 2

The figure shows a 5-pos. version of the product

Order No.	1998784
Ord designation	PCV 6-16/ 2-G1-10,16
EAN	4046356038287
Pack	50 Pcs.
Customs tariff	85366990
Weight/Piece	0.00956 KG
Catalog page information	Page 374 (CC-2007)

▶ Product notes

WEEE/RoHS-compliant since: 05/18/2004



IMPORTANT : This date is valid for Customers in Germany only. Date Format is MM/DD/YYYY. Please contact your local in-country Phoenix Contact location or designated business partner for a Logistics Compliant date in your area. In order to guarantee delivery of RoHS-Compliant product, please purchase Phoenix Contact parts from authorized Phoenix Contact representatives and distributors.

▶ Drawings

Drilling diagram

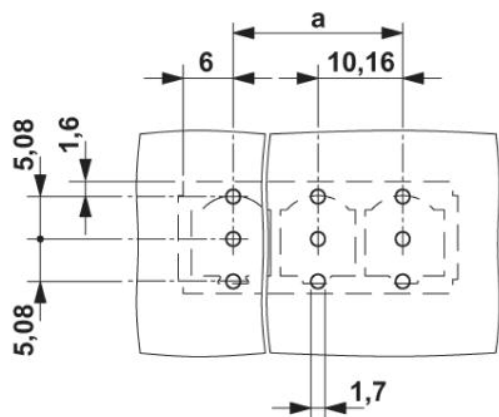

Dimensioned drawing

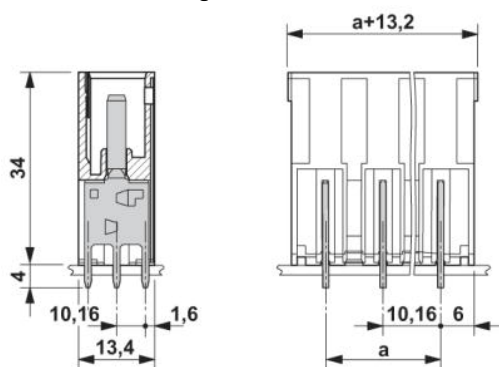

► Accessories

Item	Designation	Description
General		
1970016	CS-IPC 16/ 6	Keying peg, serves to ensure correct polarization on the PCB during manual mounting
Plug/Adapter		
1600027	CP-HCC 4	Keying profile, is inserted into the slot on the plug and header, red insulating material

► Address

PHOENIX CONTACT GmbH & Co. KG
Flachsmarktstr. 8
32825 Blomberg
Germany
Phone +49 5235 3 00
Fax +49 5235 3 41200
<http://www.phoenixcontact.de>
Phoenix Contact
Technical modifications reserved;